



PERRY STUD WELDING

A Division of TFP Corporation – Est. 1928



STUD WELDING EQUIPMENT AND ACCESSORIES CATALOG

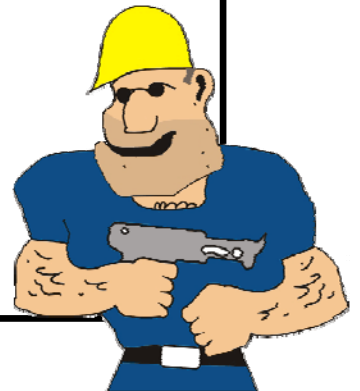

1-800-727-7883

TOLL FREE

www.weldstud.com

Sales@weldstud.com

2821 Cole Court • Norcross • Georgia • 30071
(678) 728-0095 Phone • (678) 728-0098 FAX

FERRULE GRIPS

CLOSED FERRULE GRIP (1" LONG) BRASS

<u>STUD SIZE</u>	<u>FOOT SIZE</u>	<u>GRIP DIA.(D)</u>	<u>PART NO.</u>	<u>PRICE</u>
3/16	SMALL	.305	GN-019	
1/4	SMALL	.380	GN-025	
5/16	SMALL	.445	GN-031	
3/8	SMALL	.505	GN-037	
7/16	SMALL	.585	GN-043	
1/2	SMALL	.650	GN-050	
5/8	MEDIUM	.785	GN-062	
3/4	MEDIUM	1.030	GN-075	
7/8	LARGE	1.203	GN-087	
1"	LARGE	1.406	GN-100	

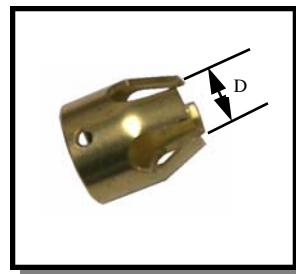

SPLIT FERRULE GRIP (1" LONG) BRASS

<u>STUD SIZE</u>	<u>FOOT SIZE</u>	<u>GRIP DIA.(D)</u>	<u>PART NO.</u>	<u>PRICE</u>
3/16	SMALL	.305	GC-019	
1/4	SMALL	.380	GC-025	
5/16	SMALL	.445	GC-031	
3/8	SMALL	.505	GC-037	
7/16	SMALL	.585	GC-043	
1/2	SMALL	.650	GC-050	
5/8	MEDIUM	.785	GC-062	
3/4	MEDIUM	1.030	GC-075	
7/8	LARGE	1.203	GC-087	
1"	LARGE	1.406	GC-100	

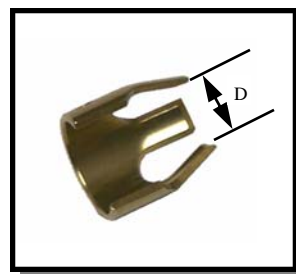

LONG SPLIT FERRULE GRIP (2" LONG) BRASS

<u>STUD SIZE</u>	<u>FOOT SIZE</u>	<u>GRIP DIA.(D)</u>	<u>PART NO.</u>	<u>PRICE</u>
1/4	SMALL	.380	GD-025	
5/16	SMALL	.445	GD-031	
3/8	SMALL	.505	GD-037	
7/16	SMALL	.585	GD-043	
1/2	SMALL	.650	GD-050	
5/8	MEDIUM	.785	GD-062	
3/4	MEDIUM	1.030	GD-075	

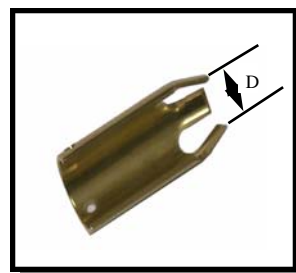

ADD \$1.00 FOR COPPER GRIPS

CHUCKS

ADJUSTABLE CHUCKS

<u>STUD DIA.</u>	<u>PART NO.</u>	<u>PRICE</u>
2MM (.079)	CN-002M	
#2	CN-008	
12 GA & #4	CN-010	
1/8 & #5	CN-012	
10 GA & #6	CN-013	
4MM (.155)	CN-004M	
#8	CN-015	
#10 & 5MM (.196)	CN-018	
6MM (.236)	CN-006M	
.215	CN-021	
.330	CN-033	
1/4	CN-025	
5/16	CN-031	
8MM	CN-008M	
3/8	CN-037	
10MM (.390)	CN-010M	
7/16	CN-043	
12MM (.472)	CN-012M	
1/2	CN-050	
14MM (.551)	CN-014M	
9/16	CN-056	
5/8	CN-062	
16MM	CN-016M	
.680	CN-068	
18MM (.708)	CN-018M	
3/4	CN-075	
7/8	CN-087	
20MM	CN-020M	
1"	CN-100	

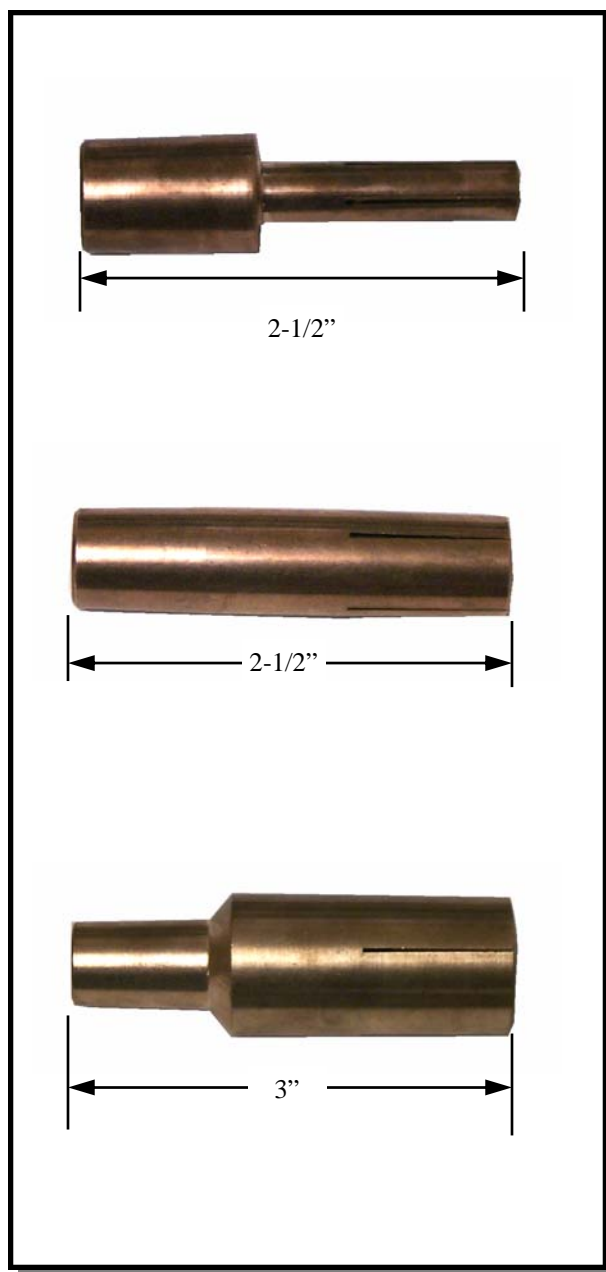

LONG AND RECTANGULAR CHUCKS

3-7/8" LONG ADJUSTABLE CHUCKS

<u>STUD SIZE</u>	<u>PART NO.</u>	<u>PRICE</u>
#6	CM-013	
#8	CM-015	
#10 & 5MM	CM-018	
6 MM	CM-006M	
1/4	CM-025	
5/16	CM-031	
8MM	CM-008M	
.330	CM-033	
3/8	CM-037	
10MM	CM-010M	
7/16	CM-043	
12MM	CM-012M	
1/2	CM-050	
9/16	CM-056	
5/8	CM-062	
3/4	CM-075	



**SIZES CM-025 AND UNDER ARE
BERYLLIUM**

4-3/4" EXTRA LONG ADJUSTABLE CHUCKS

<u>STUD SIZE</u>	<u>PART NO.</u>	<u>PRICE</u>
#6	CL-013	
#8	CL-015	
#10	CL-018	
1/4	CL-025	
5/16	CL-031	
3/8	CL-037	
7/16	CL-043	
1/2	CL-050	
5/8	CL-062	
3/4	CL-075	



**SIZES CL-025 AND UNDER ARE
BERYLLIUM**

RECTANGULAR CHUCKS

<u>STUD SIZE</u>	<u>PART NO.</u>	<u>PRICE</u>
1/8 X 1/4	CR-CA	
1/8 X 3/8	CR-CB	
1/8 X 5/8	CR-CC	
1/8 X 7/8	CR-CH	
1/8 X 1"	CR-CE	
1/4 X 3/4	CR-CF	

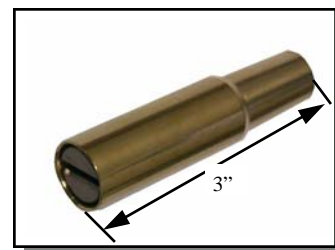

HEADED STUD CHUCKS

3/8 DIA. HEADED ANCHOR CHUCK (3/4" DIA. HEAD)

<u>PART NO.</u>	<u>DESCRIPTION</u>	<u>PRICE</u>
CH-037	COMPLETE ASSY.	
CH-037-1	SLEEVE ONLY	
CH-037-2	BASE ONLY	
CH-037-3	STOP SCREW	
SCREWS	10-32 X 3/8	

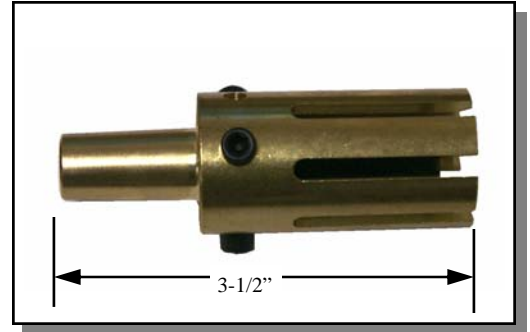

1/2 DIA. HEADED ANCHOR CHUCK (1" DIA. HEAD)

<u>PART NO.</u>	<u>DESCRIPTION</u>	<u>PRICE</u>
CH-050	COMPLETE ASSY.	
CH-050-1	SLEEVE ONLY	
CH-050-2	BASE ONLY	
CH-050-3	STOP SCREW	

5/8 & 3/4 DIA. HEADED ANCHOR CHUCK (1-1/4" DIA. HEAD)

<u>PART NO.</u>	<u>DESCRIPTION</u>	<u>PRICE</u>
CH-075	COMPLETE ASSY.	
CH-075-1	SLEEVE ONLY	
CH-075-2	BASE ONLY	
CH-075-3	STOP SCREW	

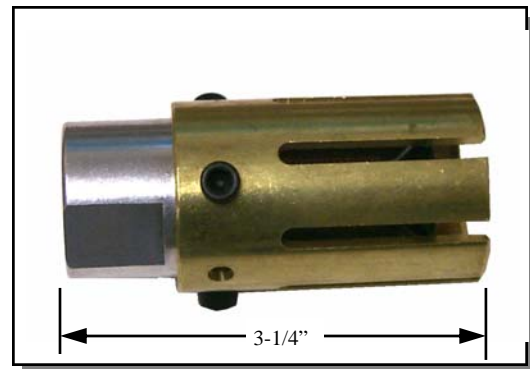

7/8 DIA. HEADED ANCHOR CHUCK (1-3/8" DIA. HEAD)

<u>PART NO.</u>	<u>DESCRIPTION</u>	<u>PRICE</u>
CH-087	COMPLETE ASSY.	
CH-087-1	SLEEVE ONLY	
CH-087-2	BASE ONLY	
CH-075-3	STOP SCREW	

1" DIA. HEADED ANCHOR CHUCK (1-5/8 DIA. HEAD)

<u>PART NO.</u>	<u>DESCRIPTION</u>	<u>PRICE</u>
CH-100	COMPLETE ASSY.	
CH-100-1	SLEEVE ONLY	
CH-100-2	BASE ONLY	
CH-075-3	STOP SCREW	
SCREWS	10-32 X 1/2	

SPECIAL CHUCKS / LEGS

Y ANCHOR CHUCKS



<u>ANCHOR SIZE</u>	<u>PART NO.</u>	<u>PRICE</u>
3/16	CY-018	
1/4	CY-025	
5/16	CY-031	

ARC STUD WELDING LEGS



<u>LENGTH</u>	<u>DIA.</u>	<u>PART NO.</u>	<u>PRICE</u>
7"	5/16	L-03107	
9"	5/16	L-03109	
14"	5/16	L-03114	
18"	5/16	L-03118	
7"	3/8	L-03707	
9"	3/8	L-03709	
14"	3/8	L-03714	
18"	3/8	L-03718	
24"	3/8	L-03724	
27"	3/8	L-03727	
32"	3/8	L-03732	
36"	3/8	L-03736	
48"	3/8	L-03748	
5/16 LEG WASHER		L-031-1	
5/16 LEG SCREW		L-031-2	
3/8 LEG WASHER		L-037-1	
3/8 LEG SCREW		L-037-2	

BENT STUD CHUCK



<u>STUD DIA.</u>	<u>BEND</u>	<u>PART NO.</u>	<u>PRICE</u>
3/8	90 deg	CB-037-90	
3/8	45 deg	CB-037-45	
1/2	90 deg	CB-050-90	
1/2	45 deg	CB-050-45	
5/8	90 deg	CB-062-90	
5/8	45 deg	CB-062-45	
3/4	90 deg	CB-075-90	
3/4	45 deg	CB-075-45	

MALE CHUCKS

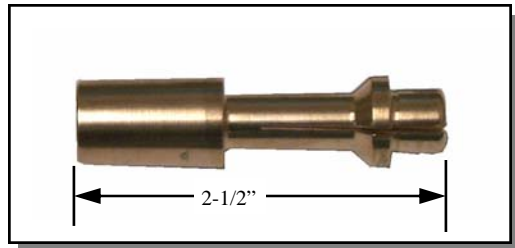

<u>HOLE SIZE</u>	<u>PART NO.</u>	<u>PRICE</u>
8/32	CX-008-32	
10-24	CX-010-24	
10-32	CX-010-32	
1/4-20	CX-025-20	
5/16-18	CX-031-18	
3/8-16	CX-037-16	
1/2-13	CX-050-13	
5/8-11	CX-062-11	
3/4-10	CX-075-10	
1/4	CX-025	
3/8	CX-037	
1/2	CX-050	
5/8	CX-062	

MISCELLANEOUS GUN PARTS

DESCRIPTION PART NO. PRICE



Connector Stud 033-506



Threaded Chuck Extension 033-504



Tapered Chuck Adapter 033-505

WELD THRU DECK ACCESSORIES

WELD THRU DECK FOOT ASSEMBLY



PART NO.	DESCRIPTION	PRICE
B-0021	FOOT ASSY.	
B-0021-1	FOOT ONLY	
B-0021-2	EXTENSION BAR	
B-0021-3	1/4-20 X 1 SCREWS	

WELD THRU DECK FERRULE HOLDER



PART NO.	DESCRIPTION	PRICE
B-0060-1	3/4 WTD/7/8 FLAT	
B-0060-2	3/4 FLAT	
B-0060-3	5/8 FLAT	
B-0060-4	1" FLAT	
B-0060-5	1/2 FLAT	

REFRACTORY FERRULE FOOT PLATE

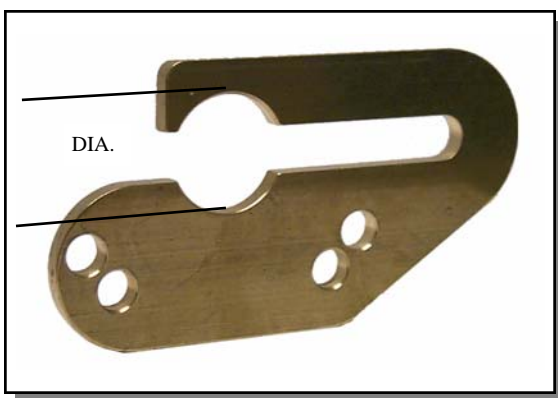

PART NO.	NECK DIA.	PRICE
QY-025-1	.810	
QY-025-2	.930	
QY-025-3	1.030	

HEAVY DUTY FERRULE GRIP



PART NO.	STUD DIA.	PRICE
GH-050	1/2	
GH-062	5/8	
GH-075	3/4	
GH-087	7/8	
GH-100	1	

CLOSED FEET



B-1N

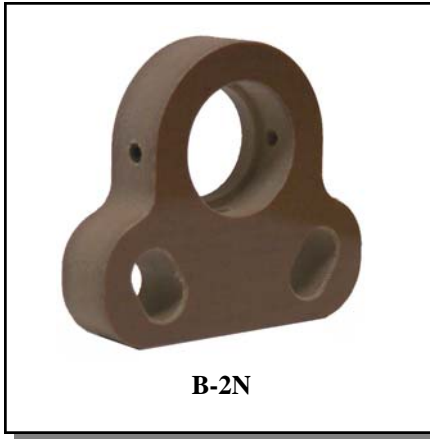

B-2N



B-3N

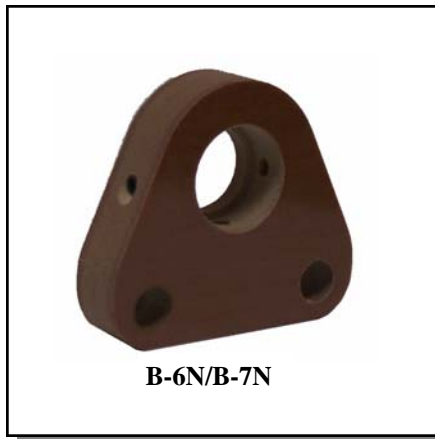

B-6N/B-7N



B-4N/B-5N



028-833

STANDARD CLOSED FEET

<u>GUN TYPE</u>	<u>STUD SIZE</u>	<u>PART NO.</u>	<u>PRICE</u>
PRO-WELD INT.	1/8-1/2	B-1N	
NELSON NS-20	1/8-1/2	B-1N	
NELSON NS-30	1/8-1/2	B-6N	
PRO-WELD INT.	5/8-3/4	B-2N	
NELSON NS-20	5/8-3/4	B-2N	
NELSON NS-30	5/8-3/4	B-7N	
PRO-WELD INT.	7/8-1"	B-3N	
NELSON NS-20	7/8-1"	B-3N	
BANTAM A-58	1/8-1/2	B-4N	
BANTAM A-58	5/8-3/4	B-5N	
PRO-WELD INT.	1/8-3/8	028-833	

SPLIT FEET

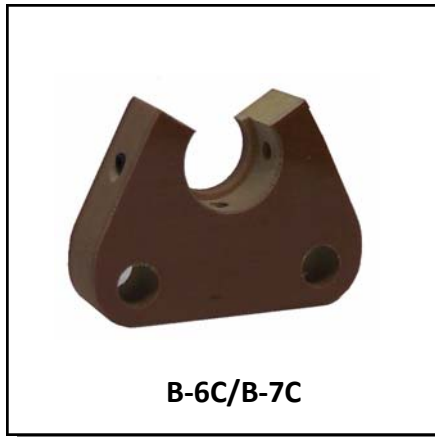

STANDARD SPLIT FEET

<u>GUN TYPE</u>	<u>STUD SIZE</u>	<u>PART NO.</u>	<u>PRICE</u>
PRO-WELD INT.	1/8-1/2	B-1C	
NELSON NS-20	1/8-1/2	B-1C	
NELSON NS-30	1/8-1/2	B-6C	
PRO-WELD INT.	5/8-3/4	B-2C	
NELSON NS-20	5/8-3/4	B-2C	
NELSON NS-30	5/8-3/4	B-7C	
PRO-WELD INT.	7/8-1"	B-3C	
NELSON NS-20	7/8-1"	B-3C	
BANTAM A-58	1/8-1/2	B-4C	
BANTAM A-58	5/8-3/4	B-5C	
BANTAM C-2	1/8-1/2	B-4CR (RECESSED)	
BANTAM C-2	5/8-3/4	B-5CR (RECESSED)	

SPECIAL FEET AND FERRULE PLATES

SPLIT BI-POD FEET

<u>STUD SIZE</u>	<u>PART NO.</u>	<u>PRICE</u>
1/8-1/2	BP-1C	
5/8-3/4	BP-2C	
7/8-1"	BP-3C	



CLOSED BI-POD FEET

<u>STUD SIZE</u>	<u>PART NO.</u>	<u>PRICE</u>
1/8-1/2	BP-1N	
5/8-3/4	BP-2N	
7/8-1"	BP-3N	



****NOTE: PLEASE SPECIFY GUN TYPE****

TWIN LEG FERRULE FOOT PLATE

<u>STUD SIZE</u>	<u>PART NO.</u>	<u>PRICE</u>
1/4	QN-025	
5/16	QN-031	
3/8	QN-037	
1/2	QN-050	
5/8	QN-062	
3/4	QN-075	
7/8	QN-087	
1"	QN-100	



SINGLE LEG FERRULE FOOT PLATE

<u>STUD SIZE</u>	<u>PART NO.</u>	<u>PRICE</u>
1/4	QM-025	
3/8	QM-037	
1/2	QM-050	
5/8	QM-062	
3/4	QM-075	
7/8	QM-087	



SPECIAL ACCESSORIES

FERRULE TUBING

STUD SIZE	PART NO.	I.D.	O.D.	L	PRICE
#8	MP-015	.291	.360	36"	
#10	MP-018	.305	.375	36"	
1/4	MP-025	.380	.500	36"	
5/16	MP-031	.445	.562	36"	
3/8	MP-037	.505	.625	36"	
7/16	MP-043	.585	.687	36"	
1/2	MP-050	.650	.750	36"	
5/8	MP-062	.785	.906	36"	
3/4	MP-075	1.030	1.156	36"	

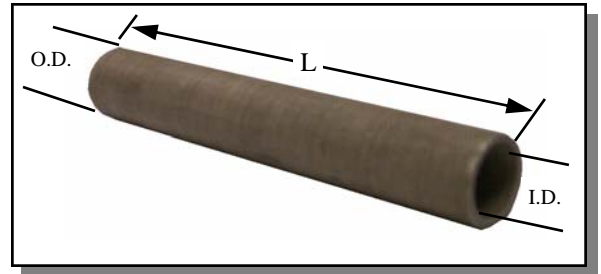

FERRULE TUBE BUSHING

STUD SIZE	PART NO.	I.D.	O.D.	PRICE
#8	MB-015	.360	.875	
#10	MB-018	.375	.875	
1/4	MB-025	.500	.875	
5/16	MB-031	.562	.875	
3/8	MB-037	.625	.875	
7/16	MB-043	.687	.875	
1/2	MB-050	.750	.875	
5/8	MB-062	.906	1.156	

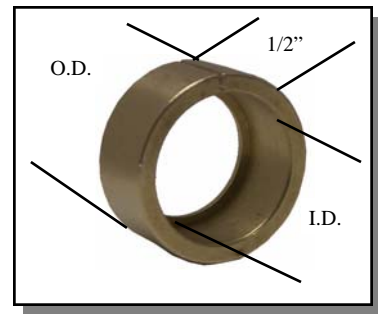

GAS ADAPTOR FEET FOR ALUMINUM WELDING (SPECIFY GUN TYPE WHEN ORDERING)



PART NO. BG-1
USE WITH FERRULE



PART NO. BG-2
USE WITHOUT FERRULE

FOOT ONLY BG-2-1
SPARK SHIELD ONLY BG-2-2
VALVE ASSY. BG-2-3



PART NO. BG-3
USE W/ARC-656 GAS UNIT

FOOT ONLY BG-3-1
SPARK SHIELD ONLY BG-3-2
HOSE CONNECTOR 119-0010

CAPACITOR DISCHARGE ACCESSORIES

“B” COLLETS

<u>STUD DIA.</u>	<u>PART NO.</u>	<u>PRICE</u>
3 MM	CDB-003M	
14 GA	CDB-008	
12 GA & #4	CDB-010	
1/8 GA & #5	CDB-012	
10 GA & #6	CDB-013	
4 MM	CDB-004M	
#8	CDB-015	
#10	CDB-018	
5 MM	CDB-005M	
6 MM	CDB-006M	
.215	CDB-021	
1/4	CDB-025	
5/16	CDB-031	

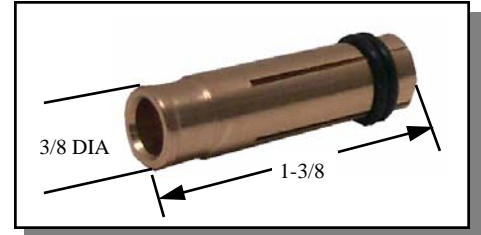

“B” COLLETS AGM STYLE

<u>STUD DIA.</u>	<u>PART NO.</u>	<u>PRICE</u>
14 GA	CDB-008A	
12 GA	CDB-010A	
#6	CDB-013A	
#8	CDB-015A	
#10	CDB-018A	
1/4	CDB-025A	

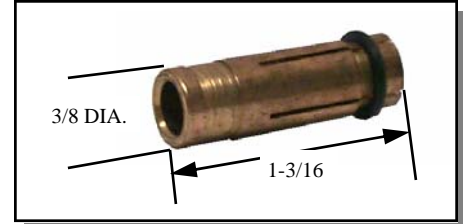

SOYER COLLETS

<u>STUD DIA.</u>	<u>PART NO.</u>	<u>PRICE</u>
#6	CDBS-013	
4 MM	CDBS-004M	
#8	CDBS-015	
#10	CDBS-018	
5 MM	CDBS-005M	
6 MM	CDBS-006M	
1/4	CDBS-025	
5/16	CDBS-031	

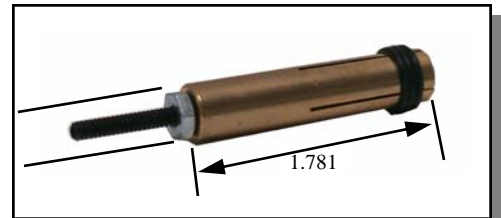

CAPACITOR DISCHARGE ACCESSORIES

ONE PIECE CONTACT/MAGNETIC CHUCK

PART NO.	PRICE
039-613	

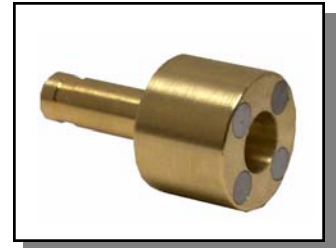

MAGNETIC CHUCK

PART NO.	DESCRIPTION	PRICE
035-301	COMPLETE ASSY	
017-633	MAGNET ONLY	
029-615	CONDUCTOR PLATE	
039-609	INSUL. TUBE	
039-610	INSUL. DISC	
SCREW	10-32 X 7/8	



"B" COLLETS PROTECTOR

STUD SIZE	PART NO.	PRICE
14 GA X 12 GA	028-837	
10 GA	028-838	
BODY ONLY	028-836	
12 GA INSERT	028-834	
10 GA INSERT	028-835	



"B" STOP

STUD	STOP	PART NO.	PRICE
1/4	1-1/4	033-781	
3/8	1-1/8	033-782	
1/2	1"	033-783	
5/8	7/8	033-784	
3/4	3/4	033-785	
7/8	5/8	033-775	
1"	1/2	033-776	
1-1/8	3/8	033-777	
1-1/4	1/4	033-778	
1-3/8 (BUTTON STOP)	1/8	033-779	
UNIVERSAL		033-780	



SHORT BUTTON STOP



UNIVERSAL "B" STOP

CAPACITOR DISCHARGE ACCESSORIES

COLLETS INSERTS FOR WELD STUDS

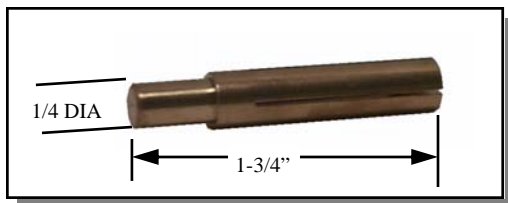

STUD DIA. X DEPTH	PART NO.	PRICE
#4 X 1/4	CI-010-025	
#4 X 3/8	CI-010-037	
#4 X 1/2	CI-010-050	
#4 X 1"	CI-010-100	
#6X 1/4	CI-013-025	
#6 X 3/8	CI-013-037	
#6 X 1/2	CI-013-050	
#6 X 5/8	CI-013-062	
#6 X 3/4	CI-013-075	
#6X 1"	CI-013-100	
10GA X 1/2	CI-014-050	
10GA X 3/4	CI-014-075	
10GA X 1	CI-014-100	
#8X 1/4	CI-015-025	
#8 X 3/8	CI-015-037	
#8 X 1/2	CI-015-050	
#8 X 5/8	CI-015-062	
#8 X 3/4	CI-015-075	
#8X 1"	CI-015-100	
#10 X 1/4	CI-018-025	
#10 X 3/8	CI-018-037	
#10 X 1/2	CI-018-050	
#10 X 5/8	CI-018-062	
#10 X 3/4	CI-018-075	
#10X 1"	CI-018-100	
1/4 X 1/4	CI-025-025	
1/4 X 3/8	CI-025-037	
1/4 X 1/2	CI-025-050	
1/4 X 5/8	CI-025-062	
1/4 X 3/4	CI-025-075	
1/4 X 1"	CI-025-100	
5/16 X 3/8	CI-031-037	
5/16 X 1/2	CI-031-050	
5/16 X 5/8	CI-031-062	
5/16 X 3/4	CI-031-075	
5/16 X 1"	CI-031-100	
3/8 X 1/2	CI-037-050	
3/8 X 3/4	CI-037-075	
3/8 X 1"	CI-037-100	

COLLETS INSERTS FOR WELD PINS



STUD DIA. X DEPTH	PART NO.	PRICE
12GA X 1/2	CIP-010-050	
12GA X 3/4	CIP-010-075	
12GA X 1"	CIP-010-100	
10GA X 1/2	CIP-014-050	
10GA X 3/4	CIP-014-075	

STANDARD SPARK SHIELD



STUD RANGE	PART NO.	PRICE
14 GA - #6	033-764	

VENTED SPARK SHIELD



STUD RANGE	PART NO.	PRICE
14 GA - 10 GA	033-769	

TEMPLATE TUBE ADAPTOR



TEMPLATE I.D.	PART NO.	PRICE
1" DIA.	039-839	
1-1/4" DIA.	039-840	

ADAPTORS

B-CI ADAPTOR

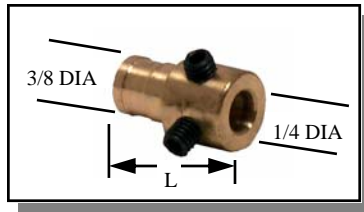

PARTNO.	PRICE
044-082	7/8 LONG
033-746	1-9/16 LONG

K-B ADAPTORS

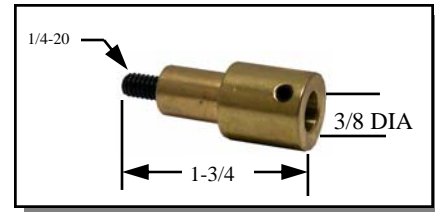

PART NO.	PRICE
039-464	

B-N ADAPTOR

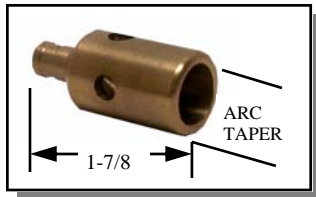

PART NO.	PRICE
039-468	

K-N ADAPTORS

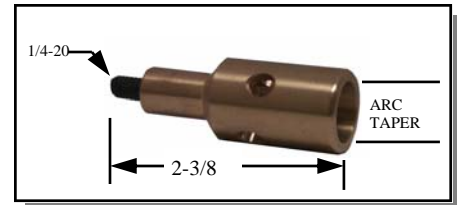

PART NO.	PRICE
033-750	

ADAPTORS

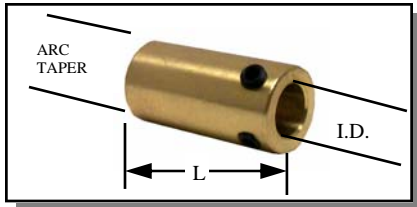

PART NO	.I.D.	PRICE
044-083 N-B	3/8 ID	
044-084 N-C	1/4 ID	

THREADED TAPERED ADAPTORS



PART NO.	PRICE
MT-0003	

MISCELLANEOUS ADAPTORS

PART NO.	DESCRIPTION	PRICE
MT-0008	TEMPLATE TUBE 1/4-1/2 ARC STUDS	
MT-0012	TEMPLATE TUBE 5/8-3/4 ARC STUDS	
033-505L	L-TEC CHUCK ADAPTOR	
033-749	K-CI ADAPTORS	
751-458-049	NS-30 CHUCK ADAPTORS	

PART NO.	DESCRIPTION	PRICE
033-505	Chuck Adaptor	
033-506	Connector Stud	

WELD CABLE CONNECTORS

HEAVY DUTY HI TEMP CONNECTOR



<u>PART NO.</u>	<u>DESCRIPTION</u>	<u>PRICE</u>	<u>PART NO.</u>	<u>DESCRIPTION</u>	<u>PRICE</u>
107-0006	4/O (M) HI TEMP		107-0007	4/O (F) HI TEMP	
107-0006-1	4/O (M) SLEEVE		107-0007-1	4/O (F) SLEEVE	
107-0006-2	4/O BRASS ONLY		107-0007-2	4/O BRASS ONLY	
107-0007-MF	HI TEMP PIN		(FITS (M) OR (F))		
COPPER WRAP					

LIGHT DUTY CONNECTOR



<u>PART NO.</u>	<u>DESCRIPTION</u>	<u>PRICE</u>
107-0010	1/O (M) FIBER SHELL	
107-0011	1/O (F) FIBER SHELL	
107-0012	#4 (M) FIBER SHELL	

CONTROL CABLE CONNECTORS

CONTROL CABLE CONNECTOR



<u>PART NO.</u>	<u>DESCRIPTION</u>	<u>PRICE</u>
107-0014	MALE 4 POLE CONNECTOR	
107-0015	FEMALE 4 POLE CONNECTOR	
107-0001	PANEL MOUNT CONNECTOR	

HUBBELL STYLE CONNECTOR



2-WIRE (M)

PANEL MOUNT

HUBBELL (M)

<u>PART NO.</u>	<u>DESCRIPTION</u>	<u>PRICE</u>
107-0016	2-WIRE (M)	
107-0017	2-WIRE (F)	
107-0018	2-WIRE (PANEL MOUNT)	
107-0019	(M) RUBBER COVER	
107-0020	(F) RUBBER COVER	
107-0030	HUBBELL (M)	
107-0032	HUBBELL (F)	
107-0031	HUBBELL (PANEL MOUNT)	

PANEL MOUNT CAMLOK CONNECTORS



<u>PART NO.</u>	<u>DESCRIPTION</u>	<u>PRICE</u>
107-0003	MALE PANEL MOUNT	
107-0002	FEMALE PANEL MOUNT	

WELD CABLE LUGS



<u>PART NO.</u>	<u>DESCRIPTION</u>	<u>PRICE</u>
123-0003	#4 W/#10 HOLE	
123-0001	#1 W/#10 HOLE	
123-0006	#1 W/1/4 HOLE	
123-0002	#1 W/3/8 HOLE	
123-0008	1/O W/3/8 HOLE	
123-0009	1/O W/1/2/ HOLE	
123-0013	4/O W/3/8 HOLE	
123-0010	4/O W/1/2/ HOLE	

ACCESSORIES



<u>PART NO.</u>	<u>DESCRIPTION</u>	<u>PRICE</u>
102-0041	ALLEN WRENCH SET	
102-0042	CHUCK EJECTOR KEY	



PERRY STUD WELDING

A Division of TFP Corporation – Est. 1928

Contact Address and Phone:

Perry Stud Welding
2821 Cole Court
Norcross GA 30071 USA

678-728-0095 Phone
800-727-7883 TOLL FREE
678-728-0098 Fax

Web Details:

Perry Stud Welding
[HTTP://www.weldstud.com/](http://www.weldstud.com/)
Sales@weldstud.com

Payment Remit To Address:

Perry Stud Welding
460 Lake Road
Medina, Ohio 44256



MADE IN AMERICA